



48511 Warm Springs Blvd., Suite 206, Fremont CA 94539

Tel: +1-510-490-8024 Fax: +1-510-623-7268

Website: <http://www.actisys.com/> E-mail: irda-info@actisys.com

ACT-IR100SD OBEX Server

IrReady Intelligent Adapter

User's Manual



October 30, 2006

Ver. 1.0

© Copyright 2000-2006 ACTiSYS Corporation
All Rights Reserved

TABLE OF CONTENTS

REVISION HISTORY	3
PRECAUTIONS	4
1. FEATURES	5
2. OVERVIEW	6
3. ARCHITECTURE OF ACT-IR100SD	7
4. HOST INTERFACE.....	8
4.1 Host Interface Signals	9
4.2 RS-232C DTE DB-9P Connector.....	9
5. OPERATING IN ACT-IR100SD	10
5.1 How to connect IR100SD with host Device:	10
5.2 How to configure the role modes and other parameters in ACT-IR100SD:	10
5.3 OBEX PUT/GET description.....	14
6. THE DEFAULT SETTING OF ACT-IR100SD.....	16
7. ACT-IR100SD DONGLE DIMENSIONS	17
8. CHARACTERISTICS AND SPECIFICATION.....	17

REVISION HISTORY

Revision History		
Revision	Date	Comment
1.0	10/30/2006	Draft Preliminary Design Specification.

PRECAUTIONS

To ensure trouble-free operation, please observe the following precautions:

Optical communications are easily affected by external light sources, weak batteries, transfer distance, transfer angle, etc.

Any of these conditions may cause a data transfer failure, incomplete or missing data. Make sure that the wireless interface is away from direct sunlight and other strong light source.

- Do not terminate arbitrarily during file transfer process between IR100SD and computers until finished. Otherwise IR100SD internal data integrity may be damaged, which is due to the violation of IR100SD's.
- Do not expose the unit to moisture, as this will damage the internal circuitry.
- Do not expose the unit to extreme temperatures. It should not be placed in direct sunlight or in a closed vehicle, neither should it be placed near heaters nor other heat sources.
- Do not store the unit in a humid or dusty place.
- Use a soft, dry cloth to clean the unit. Do not use a wet cloth or any solvent.
- Do not drop the unit or handle the unit carelessly.

CAUTION:

- Never touch the pins of computer connection terminal. The internal circuits can be damaged by a static electricity discharge. If this device requires any servicing, use only an ACTiSYS service dealer, an ACTiSYS approved service facility, or an ACTiSYS repair service.
- When exchanging data with host computer, be sure the appropriate serial communication port is available and is not in conflict with other peripheral device or software.

1. FEATURES

- A complete IrDA Protocol stack in a dongle.
- Supports both IrDA Primary and Secondary mode, changeable via PC utility.
- No driver program is needed.
- Supports mandatory IrDA layer: IrPHY, IrLAP, IrLMP and IAS.
- Supports upper layers TinyTP, IrCOMM, IrLPT, and OBEX PUT/GET server.
- Supports host baud rate from 1.2 kbps to 115.2 kbps, which is changeable by PC utility. IrDA baud rate from 9.6 kbps to 115.2 kbps, which is flexible setting by IrDA devices.
- IR frame and Host buffer are 2048 bytes separately.
- Supply voltage: 6.0 V to 12 V.
- Power consumption: 20 mA standby, 50 mA active.
- Supports 3 wires host interface (Tx, Rx and GND).
- Interface to Host:
 - Full-duplex asynchronous serial (TXD, RXD)
 - Hardware flow control (RTS, CTS)
 - Optional line status for link control (DTR, DSR)
 - Other unused inputs (RI, CD)
 - Designed for use in RS232C level and it is in DTE (Data Terminal Equipment) configuration.

2. OVERVIEW

The ACT-IR100SD is a high-integration IrDA Intelligent dongle. It provides a serial interface to a host device that intends to have Infrared communication capability. The host device can be any equipment or device that needs to communicate with IrDA enabled portable or tablet PC, PDA, cellphone and hand held data terminal, via IrDA protocol with only a wired serial interface. The ACT-IR100SD will handle all the detail about IrDA protocols. It sends and receives only user data to and from the host device via the wired serial interface with hardware flow-control. IrDA has two modes; one is Primary, and the other is Secondary. The difference between them is that a Primary mode device initiates discover, connection sequence and negotiate IrDA protocol parameters to Secondary mode device; while Secondary mode device always waits for commands from Primary mode device. Both modes can run different protocols, and both may send or receive user data. ACT-IR100SD supports both modes. When IR100SD is set to Primary mode, user can choose IrCOMM, IrLPT or OBEX PUT/GET server to be Primary protocol via a simple PC utility. Fig.1 is the system diagram.

Fig.1 System Diagram for Using ACT-IR100SD as a Communication Media

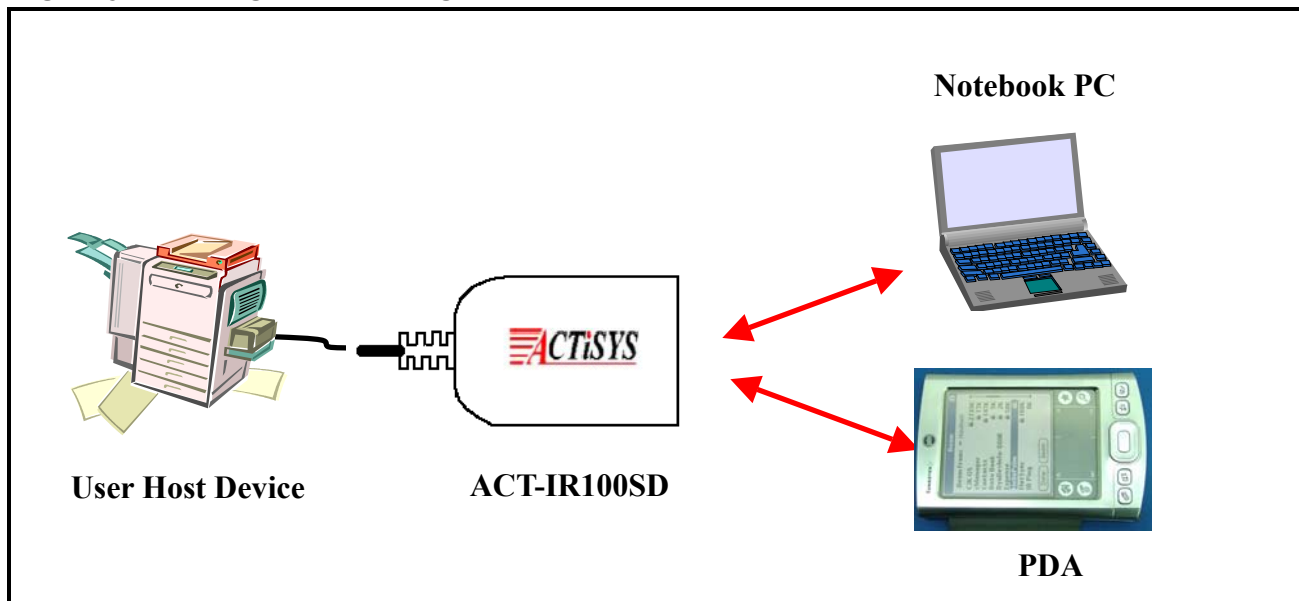

3. ARCHITECTURE OF ACT-IR100SD

The mandatory IrDA protocol layers, IrLAP and IrLMP (including IAS) are handled by ACT-IR100SD, In addition, TinyTP, IrCOMM, IrLPT and OBEX transport are also included.

The incoming/outgoing IrDA user data payload are buffered and then transferred to/from the host. The baud rates of IrDA traffic and host interface are independent of each other. The flow controls of IrDA traffic and host interface are also independent of each other.

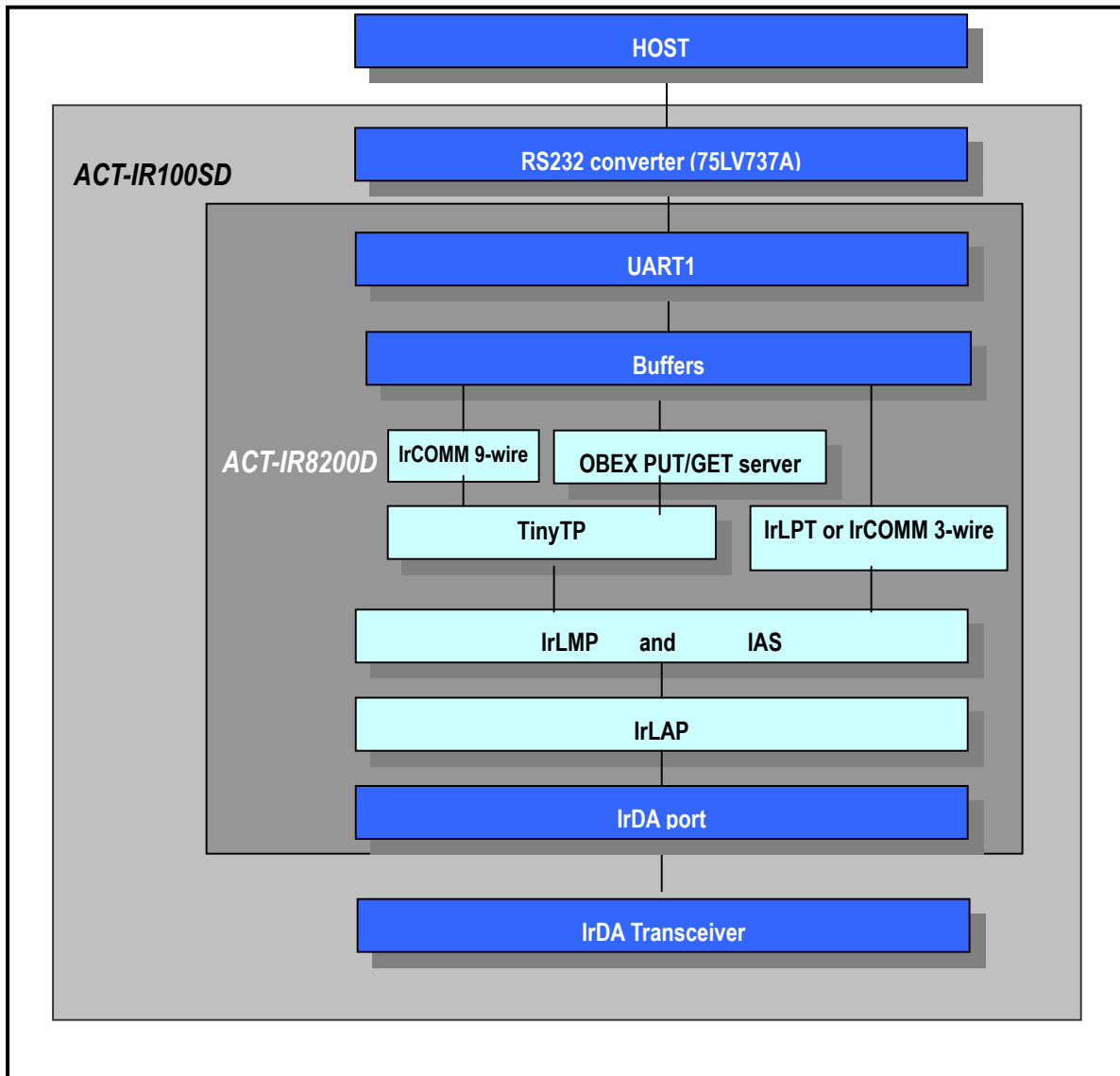

4. HOST INTERFACE

The host interface of ACT-IR100SD is a full-duplex asynchronous RS232 DB9M connector. The following table is the signals of DB9M connector. It can be treated as DTE. The data bytes are transmitted via TXD pin and received via RXD. Each data byte consists of one start bit (0), 8 data bits (LSB first, MSB last), a stop bit (1) and no parity bit.

Implementing H/W flow control signals in host end is recommended. Since ACT-IR100SD is a buffer limited dongle. Without flow control will probably cause data loss sometimes. The H/W flow control relative signals are: DTR, RTS, DSR and CTS, which are defined exactly as RS232 DTE interface.

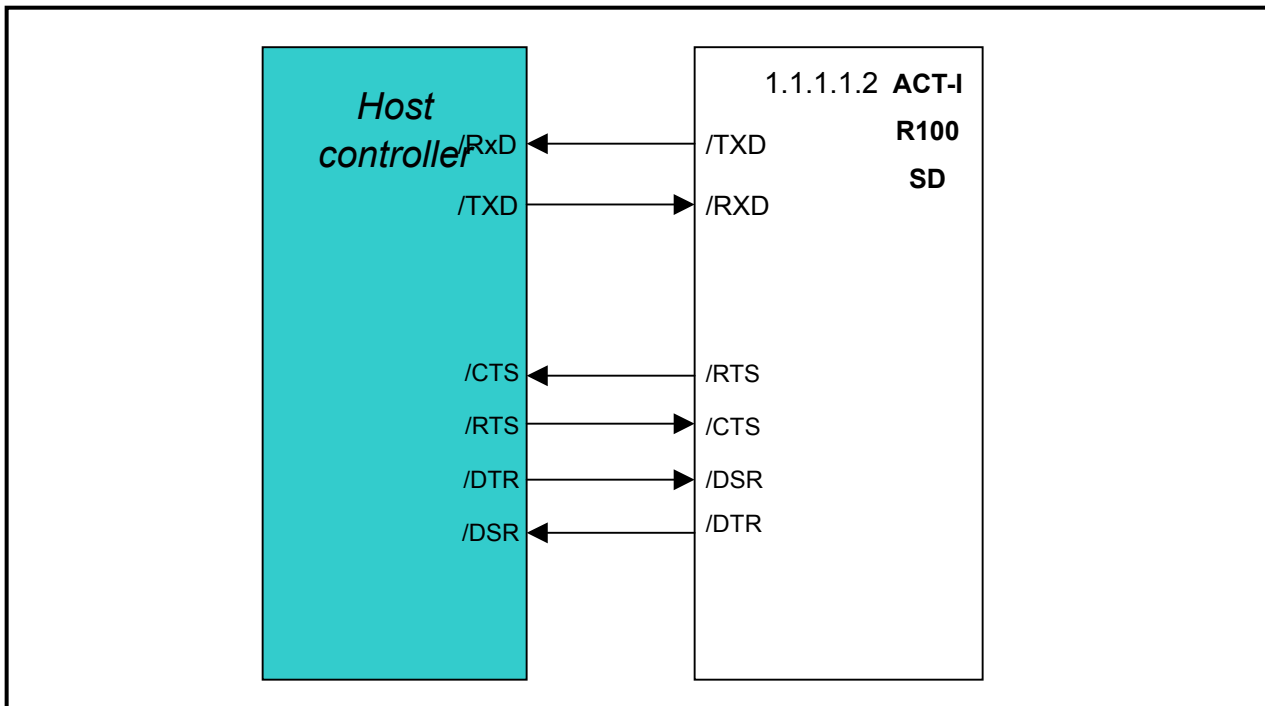
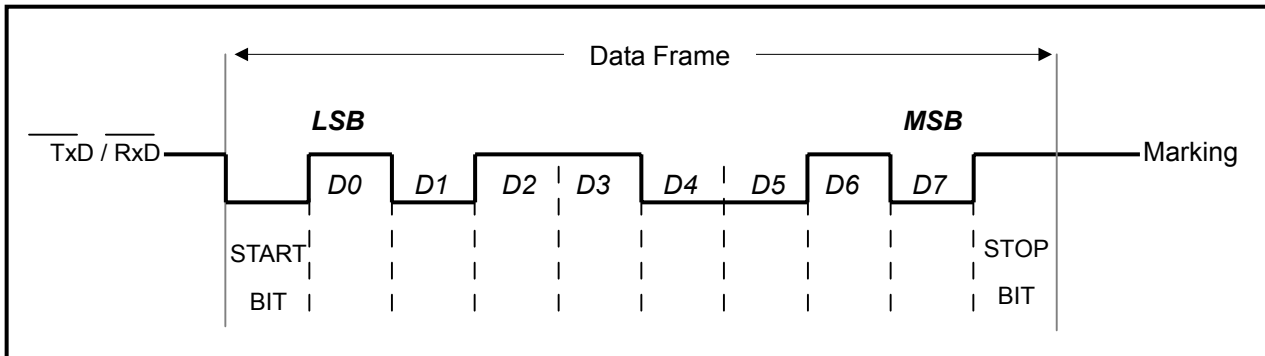

4.1 Host Interface Signals

ACT-IR100SD host interface consists of three output signals and five input signals. All these signals are low active. That is, they are at 0V when active and at VCC level when inactive. When an inverting RS232 level converter is used, the corresponding RS232 level signals are high active. That is, they are at +12V nominal when active and at -12V nominal when inactive.

1. /TXD: serial data output.
2. /RXD: serial data input.
3. /RTS: output. When hardware flow control is enabled. Active /RTS means /RXD is ready to receive. Inactive /RTS means /RXD is not ready.
4. /CTS: input. If hardware flow control is enabled, /CTS must be driven active to allow /TXD and inactive to forbid /TXD. If hardware flow control is disabled, /CTS is optional.
5. /DSR: input. If connection control is enabled, /DSR must be driven active to allow IrDA connection and inactive to forbid a new connection or terminate an existing connection. If connection control is disabled, /DSR is optional.
6. /DTR: output. If connection control is enabled, active /DTR means an IrDA connection is made. Inactive /DTR means there is no connection.
7. /CD: input. Optional.
8. /RI: input. Optional.

4.2 RS-232C DTE DB-9P Connector

Pin No.	Name	Descriptions	I/O
1	CD	Data Carrier Detect	I
2	RXD	Receiver Data	I
3	TXD	Transmitter Data	O
4	DTR	Data Terminal Ready	O
5	GND	Signal Ground	GND
6	DSR	Data Set Ready	I
7	RTS	Request to Send	O
8	CTS	Clear to Send	I
9	RI	Ring Indicator	I

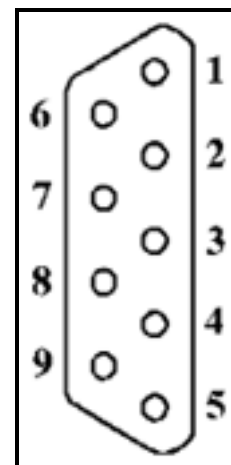

Front View

5. OPERATING IN ACT-IR100SD

5.1 How to connect IR100SD with host Device:

IR100SD uses a standard RS232 DTE port to connect with the host. If the host device is a Modem like device and has a RS232 DCE port, then use a "straight cable". That is, connect the signals with the same name from one side to the other.

All the operating procedures of IR100SD are triggered by DSR signal from HOST, (DSR for IR100SD is an input signal.) except DSR is ignored by PC utility, see section 5.2 below. When DSR is pulled high level (RS232 level) by HOST, IR100SD will send out discovery frames to outside and try to find some other IrDA devices if IR100SD is set to Primary mode. Or it is ready to receive discovery frame from another Primary device outside if IR100SD is set to Secondary mode. It depends on what mode is operating in IR100SD.

When IR100SD is connecting to another IrDA device successfully via IR, it will pull DSR signal to high (RS232 level), which also means that Host can send and receive data frame to and from another IrDA device. When DSR is pulled to low, it means that IR link is not established anymore.

5.2 How to configure the role modes and other parameters in ACT-IR100SD:

Since IR100SD supports Primary, Secondary and several parameters, Comset_IR100SD.exe is an application associated with the dongle for customers to configure IR100SD themselves.

Please attach IR100SD dongle in PC then execute Comset_IR100SD.exe in Windows system. It will show three pages of parameters for change. After any parameter is changed, you have to press "send" button on every page you change first. Then press "Save Config into Flash" so that parameters can be configured successfully.

5.2.1 The first page is to set the host baud rate and the hardware flow control.

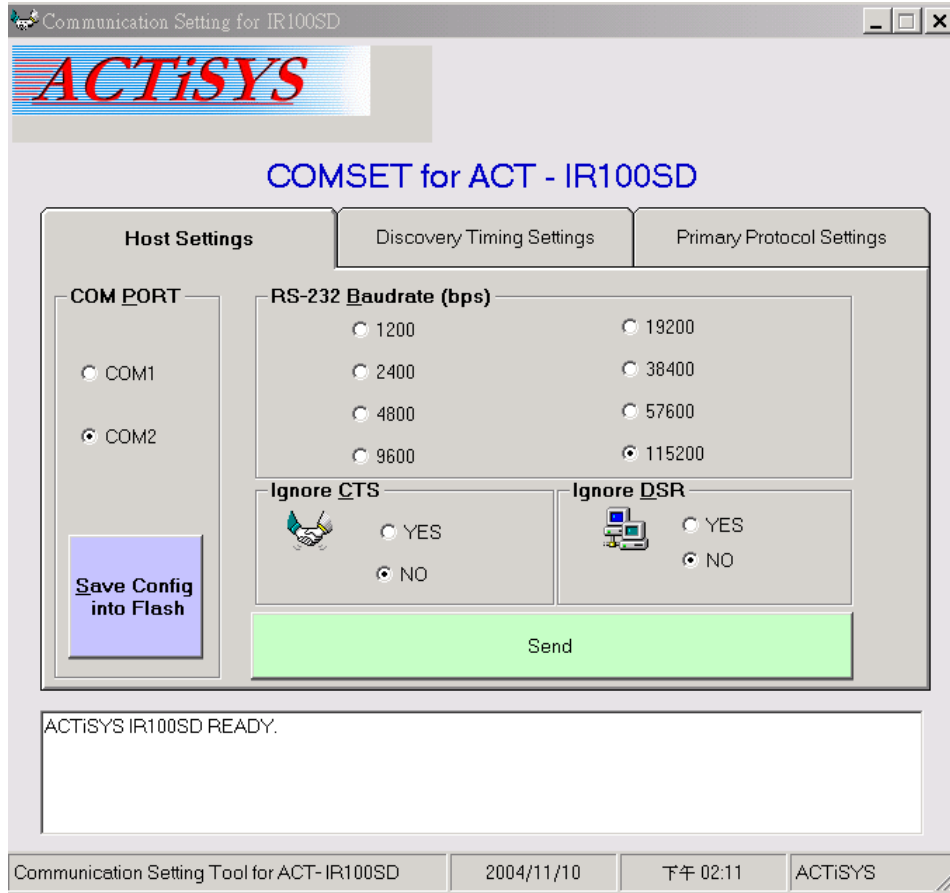

Please Note:

Ignore CTS: If host device has no hardware flow control signals, only Tx, Rx and GND, then you have to set this bit to 1. IR100SD will pass the coming data to host and doesn't care the status of CTS. **Note: Since IR100SD is a buffer limited dongle (2K bytes for host and 2K bytes for IrDA), if this bit is set, then it will cause data lost (Because no flow control). Where data loss can be solved if user sends data by segment and every segment doesn't exceed 2K bytes.**

Ignore DSR. If host system has no DSR signals, then this bit should be ignored. But since this signal triggers IR100SD into Primary mode, it will be no way to ask IR100SD disconnecting IrDA link. And IR100SD will always be in Primary once power on. In another word, once D4 is set to 1, you are not able to control IR100SD at all until power off and reset D4 to 0. This bit is recommended being set when host device is in Secondary mode.

5.2.2 The second page is to set time interval of discovery, the slot number of discovery and the mode of IR100SD.

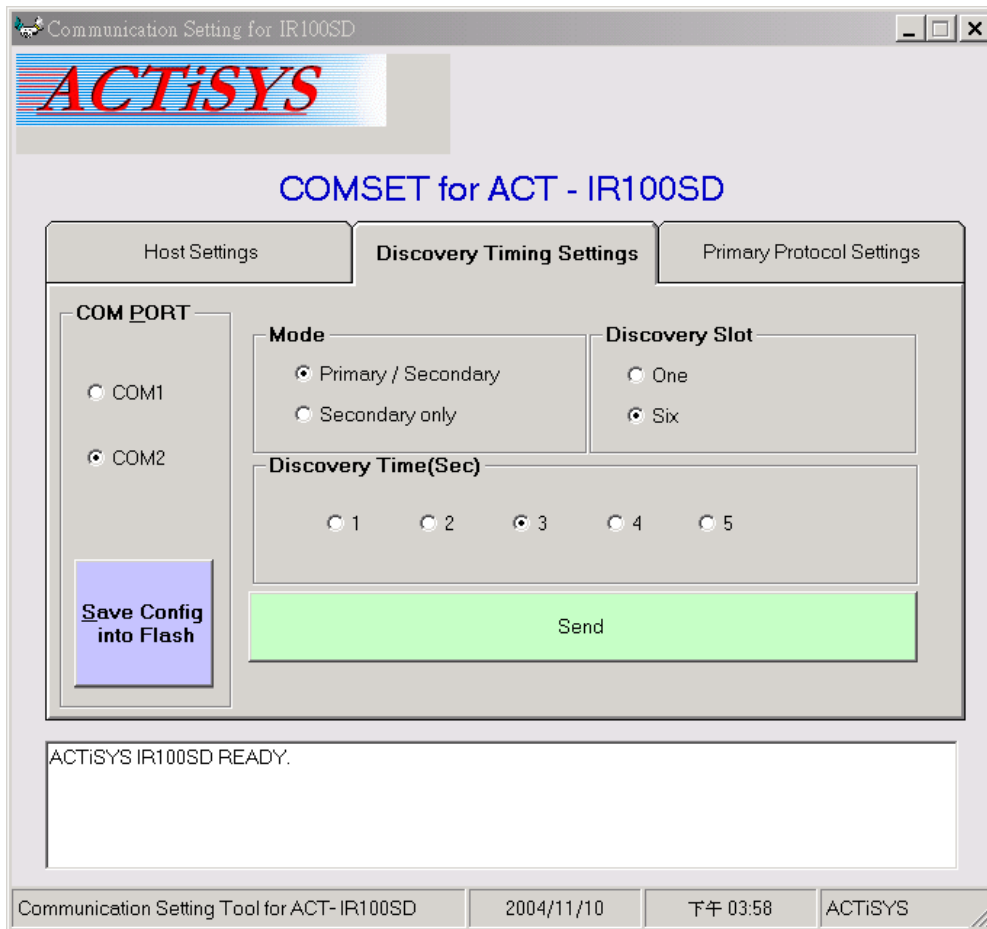

- 1) IR100SD supports both Primary and Secondary. It allows customer to change it.
- 2) Discovery time should be 3 seconds in general. If you want the discovery process faster, you can change it.
- 3) Discovery slot can also make discovery process faster.

5.2.3 The third page is to set the IrDA protocols when IR100SD is in Primary.

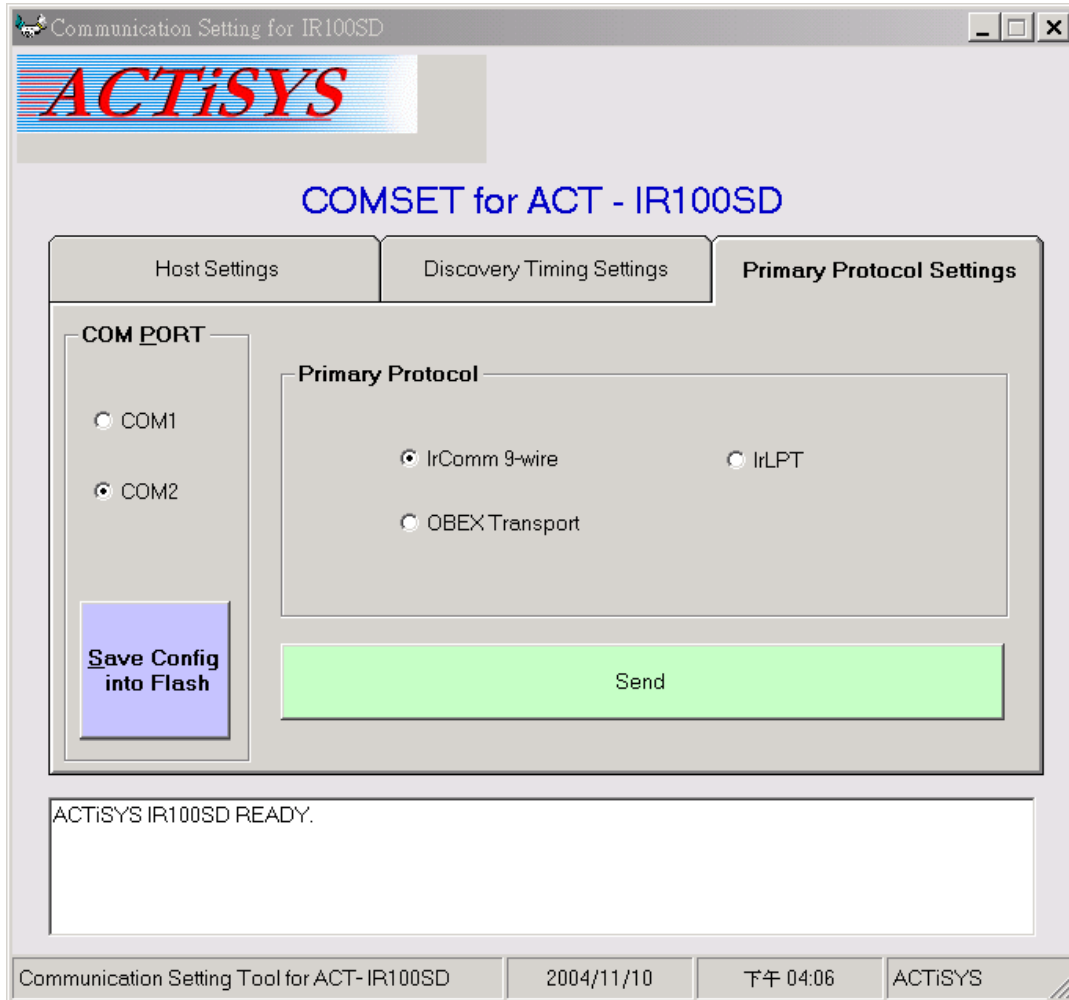

5.3 OBEX PUT/GET description

The OBEX specification consists of two major parts: a protocol and an application framework. This is also illustrated graphically below. The "application framework" is represented in ellipses inside the "wide world of applications" at the upper half of this figure. The "protocol" part is presented in five rectangles at the lower half of this figure.

Standard ACT-IR100SD doesn't and can't provide the "application framework" part of OBEX in the "wide world of applications" (the ellipses in Figure). The host system using IR100SD must **implement that part by host itself**.

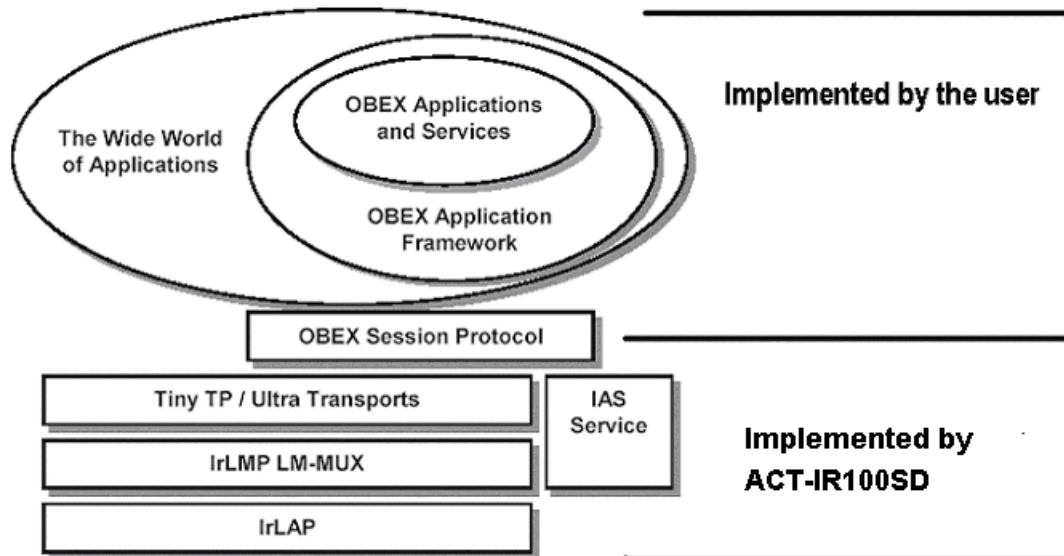

Now IR100D-OBEX-Server provides PUT/GET server in OBEX, user doesn't need to handle OBEX command and response anymore.

The following figure shows how cellphone or PDA delivers an object (maybe a phone book record, a picture or a formatted data) to user's host. When IR100SD-OBEX-Server receives OBEX PUT command, it will act like a PUT server and reply proper response. Then it will trim PUT commands sent by cellphone, only left object data itself and then pass to user's host. While transferring objects, user's host is not able to know how big this object is until it receives the entire object.

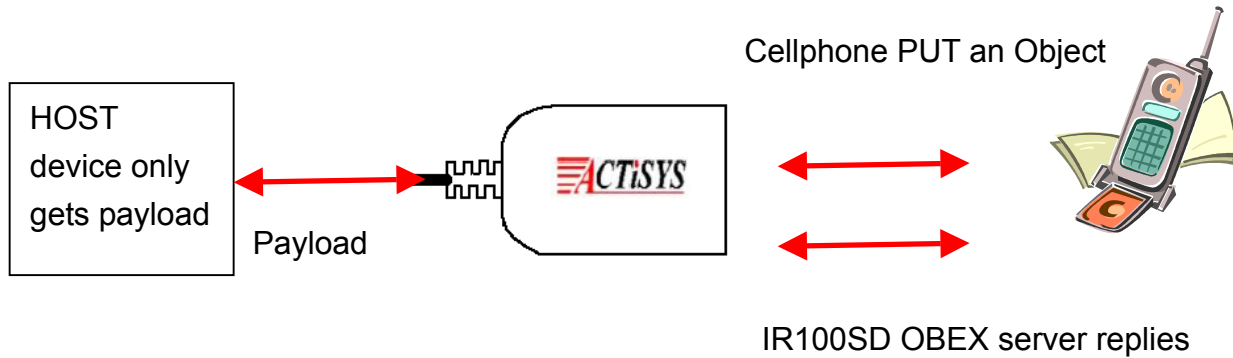

Since IR100SD-OBEX-Server can only handle server role in OBEX, so user's host can't deliver object to cellphone directly. The following figure is showing how cellphone or PDA gets some object from user's host. They have to give GET command to IR100SD-OBEX-Server. IR100SD-OBEX-Server will wait data coming from user's host and create response for GET command.

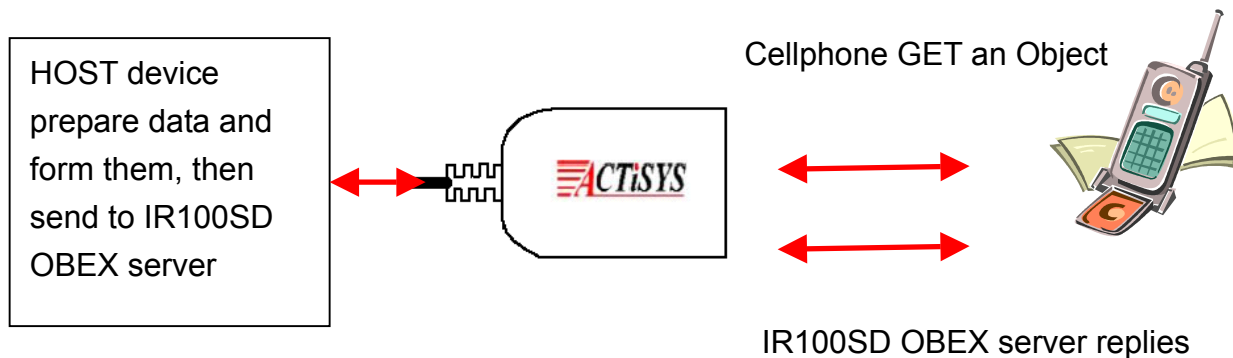

Please note that based on OBEX requirements, when user's host is going to send data to IR100SD-OBEX-Server to response GET command, user's host should tell IR100SD-OBEX-Server how big the object is first. So there is a formatted frame that user's host should obey when it sends this object.

Byte0	Byte1	Byte2	Byte3	Byte4~Byte515
0xAA	0x55	Low byte of data frame length	High byte of data frame length	Data (limited by buffer, 0~ 512 bytes)

Frame length means total frame size, including byte 0,1,2, and 3. For example, if data frame is 300 bytes, length should be 304.

6. THE DEFAULT SETTING OF ACT-IR100SD

The default setting of ACT-IR100SD is configured as the following:

Parameters	Setting
Host baud rate and data format:	115.2 kbps, 8N1
DSR/CTS	Not ignored
Device role mode	Primary/Secondary both
Discovery period	3 seconds
Discovery slots	6
Primary protocol	IrCOMM 9 wire

7. ACT-IR100SD DONGLE DIMENSIONS

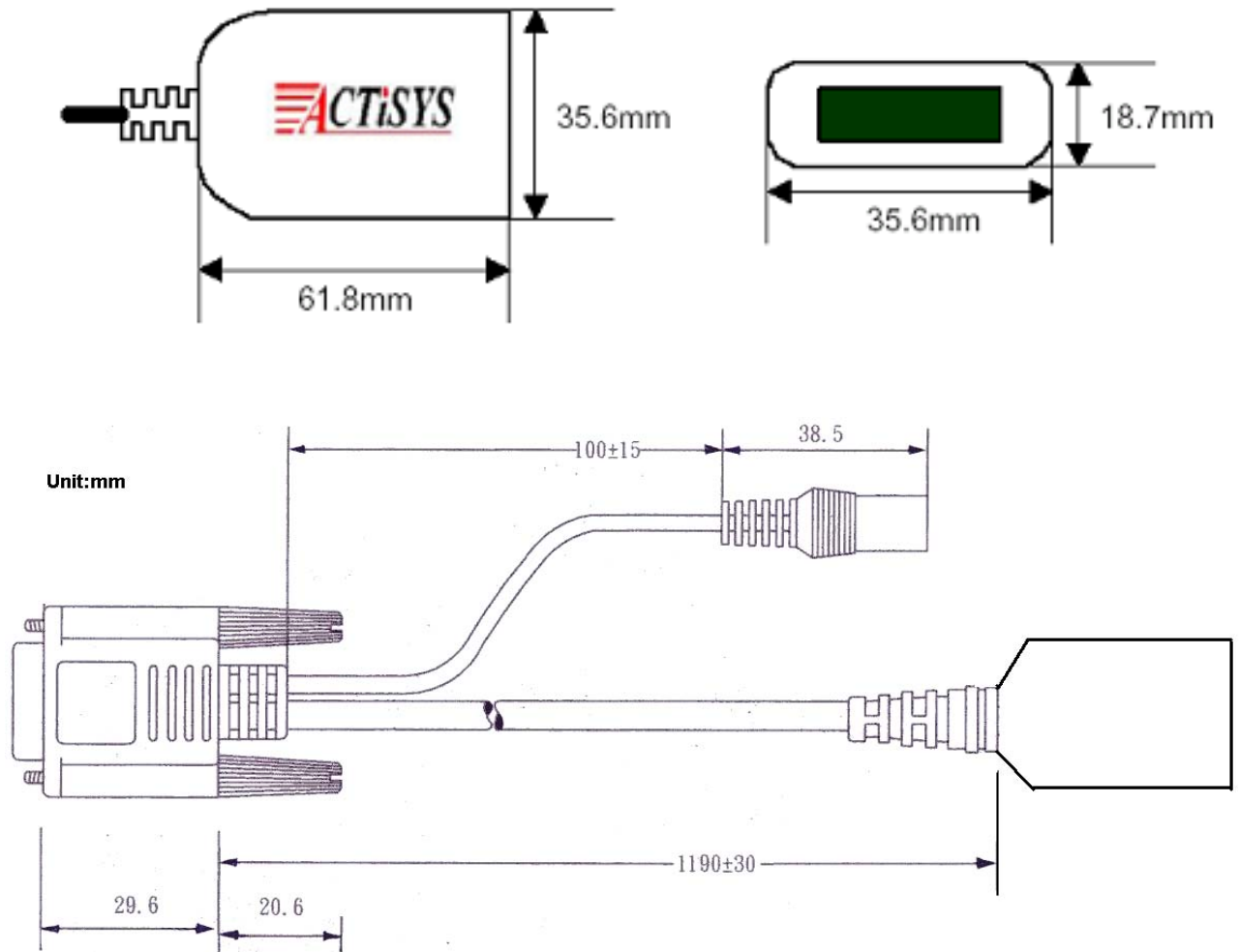

8. CHARACTERISTICS AND SPECIFICATION

Parameter	Min.	Typical	Max.	Units
DC supply voltage	6.0	7.5	12	V
Supply voltage, VSS	0			V
Operating temperature range, TA	0		60	°C
DC current (Ready mode)	20			mA
DC current (Active mode)		50	150	mA
Infrared Transmitting range	100	158	200	cm
RS232 signal threshold level	+/-3	+/-12	+/-25	V